

HEALTH MASTERY THROUGH MRT

Monitor and Master Your Health Through
MUSCLE RESPONSE TESTING

.....
YOUR BODY DOESN'T LIE!
.....

MARK VIRKLER PH.D.
AND
PATTI VIRKLER D.MIN.

"I will praise thee; for I am fearfully and wonderfully made; marvelous are thy works; and that my soul knoweth right well."

Psalms 139:14

HEALTH MASTERY THROUGH MRT

Note to reader: This book is not intended to prescribe or diagnose in any way. It is not meant to be a substitute for professional help. Those who are sick should consult a holistic doctor. Neither the author nor the publisher directly nor indirectly dispenses medical advice or prescribes. The author and the publisher assume no responsibility if you prescribe for yourself without your doctor's approval.

Copyright 1997 Mark Virkler/Patti Virkler

Published by: Christian Leadership University

ABOUT THE AUTHORS

MARK VIRKLER

Dr. Mark Virkler is president of Christian Leadership University, The Christian Restoration Fellowship International, and Communion With God Ministries. Co-author of 50 books, Mark is an avid researcher and writer, seeking to discover principles and truths which enhance people's lives in practical ways. Mark received his B.A. from Roberts Wesleyan College, Doctor of Theology from Miami Bible Institute and Doctor of Philosophy from Carolina Christian College.

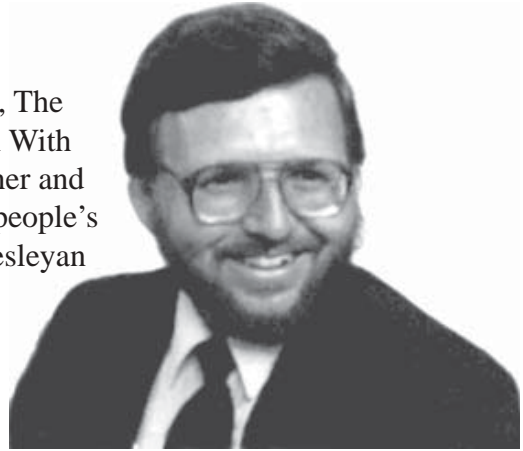

Mark was a pastor from 1970 until 1985, when his worldwide travel as a seminar speaker became full-time. He is in demand for his seminars in the areas of natural health and hearing the voice of God. His two most popular books to date have been *Communion With God* and *Go Natural!*. To obtain a list of his available publications or to book him as a seminar speaker, call 1-800-466-6961 or visit www.cwgministries.org.

PATTI VIRKLER



Patti Virkler is Academic Dean of Christian Leadership University. Patti is co-author of 50 books with her husband Mark. Patti received her B.A. from Roberts Wesleyan College, Doctor of Ministry from Vision Christian University.

Patti has homeschooled her two children, Joshua and Charity, throughout their entire school careers, both graduating with honors, excelling in their respective fields, and entering college by age 17. She has also established a Christian library for homeschoolers and is currently developing a library for Christian Leadership University.

TABLE OF CONTENTS

<i>Introduction</i>	vii
<i>Preface</i>	ix
<i>Chapter One</i>	What Makes MRT work?	1
<i>Chapter Two</i>	Where are the MRT Points?	15
<i>Chapter Three</i>	Techniques for Success in MRT	61
<i>Chapter Four</i>	Additional Training, Certification, and Ordination	77
<i>Appendix A</i>	Survey Concerning MRT Test Point Results	79
<i>Appendix B</i>	Additional Health Resources	81

INTRODUCTION:

ASTONISHED BEYOND WORDS

The first time I was exposed to Muscle Response Testing was when Dr. Wendell Whitman tested me to discover which of my bodily organs were weak and stressed, and which were strong. I held out my right arm and “resisted” as Dr. Whitman pushed down on it, while simultaneously touching various points on my body. On several test points, my arm gave way and I had no resistance in it. It was as if someone had taken away all my strength. Then Dr. Whitman placed a few different herbs in my left hand while continuing to test my right arm for muscle strength. When we hit upon the right herb to nutritionally support my body, my arm went strong again!

I couldn’t believe it! My body was telling me where it was weak and exactly what it would take to make it strong again! I was literally speechless, while at the same time being so full of questions I could hardly contain myself. I am sure I asked Wendell at least a hundred of them that night, and over the next three months, I asked another couple of hundred.

That night I was on the verge of tears. I realized I was in the presence of a master minister in the area of

healing, and that the gift that Dr. Whitman was modeling before me was something I **desperately wanted to master**. I counted it as priceless, worth whatever it would cost me to learn it.

I had one basic overriding question for Dr. Whitman that night: “Can you train me to do what you are doing?” He said he would, and invited me to attend a variety of his two-day training seminars which he conducts regularly all across the United States. During the next three months I attended six days of seminars hosted by Dr. Whitman, and he taught me the skill I am presenting to you on the following pages. I shall forever be indebted to him for teaching me this wonderful art of Muscle Response Testing. I shall use it to maintain optimum health for myself, as well as keeping my family and loved ones healthy, and offering it cheerfully to anyone who comes to me asking for this gift.

May your life be greatly enriched as you master the art of

MUSCLE RESPONSE TESTING!

PREFACE:

A STORY OF SUCCESS WITH MRT

Wouldn't it be nice to have a way for my body to tell me exactly what its needs and desires are, without having to take expensive or invasive tests? Wouldn't it be nice if I could perform these tests as often as I wanted, free of charge, and right in my own home (or anywhere I wanted), with no costly instruments necessary?

Wouldn't it be nice if I could customize a diet, as well as a vitamin, mineral, and herbal supplement program, specifically for my body rather than adopting one that was based on some national norms derived for the hypothetical "average" human body? No longer would I have to take a handful of supplements, hoping they were the right ones.

Wouldn't it be nice for a mother to always know if her children were properly nourished, and, if they were deficient in any nutrient or any organ was weak, exactly what that deficiency was and exactly how to remedy it?

With Muscle Response Testing I can do all this and more! Now my body can tell me exactly what it wants and exactly what it doesn't need. Absolutely unbelievable!

Many stories can be shared about the effectiveness of MRT. One woman had tried to become pregnant for

five years. She had tried every suggested medical procedure to no avail. Finally she switched to natural means. She tried many herbs which did not help. Then she was tested by a person with advanced skill in MRT. He discovered that her body had stored a vaccine in her right ovary. Through MRT, the specific homeopathic and potency necessary to cleanse the vaccine out of her ovary was determined. The result: she became pregnant within five days!

Simply amazing!

As I reflect on muscle response testing, I find myself weaving together pieces of information I have gathered through the years.

First, it is obvious to me in an empirical sense that my body is full of energy. Some days it has more energy than others. Some days, it downright drags, especially when I am sick. Then my energy is extremely low.

As I reflected further, I realized our words and even our thoughts carry positive and negative energy. If you say, "I hate house plants", your house plants will die. You can often sense the thoughts of others when you come into their presence. The Bible says, "And Jesus, knowing their thoughts said, 'Wherefore think ye evil

in your hearts?” (Matthew 9:4). That is actually an example of one person’s inner being sensing the thoughts of another’s inner being. Often you can walk into a room and sense the energy vibrations (“feel the vibes”) of the occupants. Inner thoughts and spoken words have a vibrational rate which affects everything in the environment.

Then I thought about a lie detector test. If a subject answers a statement truthfully, his body remains calm and strong. However, if his answer contains a lie, his body automatically reacts. The discord within his body caused by a lack of truth can be measured with a polygraph machine on a sheet of paper. Truth and untruth do cause definite physiological responses within the body. So perhaps it shouldn’t be so hard to believe we can strengthen or weaken the body’s muscles with a spoken statement or question.

Another tidbit I have heard is that symphony conductors have the longest life span of any occupation. I wonder if it is because of the healing quality of the harmonious vibrations in which they are constantly immersed. King David had worshipers continuously in the temple.

Perhaps, like me, you need to learn more about vibrations, frequency, and energy in order to understand and accept MRT. In the next section we will dive in and see what we can discover, and how it can transform your health.

MRT comes from a branch of study called “Applied Kinesiology”. The word kinesiology comes from two Greek words, “kinesis” meaning “motion”, and “ology” meaning “the study of”. Kinesiology, then, means the study of the principles related to human motion.

The Bio-My kinesiometer, used in muscle testing.



Source: Your Body Doesn't Lie, p. 46

The term “applied” according to Webster is “put to practical use”. So “applied kinesiology” is the practical application of the principles of body movement. This is what muscle response testing is all about.

Applied kinesiology is a system which uses the patient’s body as a laboratory of investigation. The response of the body is unerring. The body never lies.

Applied Kinesiology was introduced by George J. Goodhart, Jr., D.C., in Detroit, Michigan in 1964, and has grown rapidly ever since.



George J. Goodhart, Jr.
Introduced Applied Kinesiology

How trustworthy is MRT? A great degree of accuracy and reproducibility appears to be present in muscle response testing when done by individuals knowledgeable in the science and proficient in its art. Alfred Scoop evaluated the reproducibility of muscle testing using a hand-held dynamometer, with six trained examiners testing ten naive subjects. The correlation between examiners was 91%, which is a high degree of accuracy. [Alfred L. Scoop, “An Experimental Evaluation of Kinesiology in Allergy and Deficiency Disease Diagnosis,” *Journal of Orthomolecular Psychiatry*, Vol. VI, No. 2 (1978)]

The Cybex Dynamometer, another device used in muscle testing. Even the quadriceps, perhaps the strongest muscle in the body, shows a reduction to about half strength when a weakening stimulus is introduced.

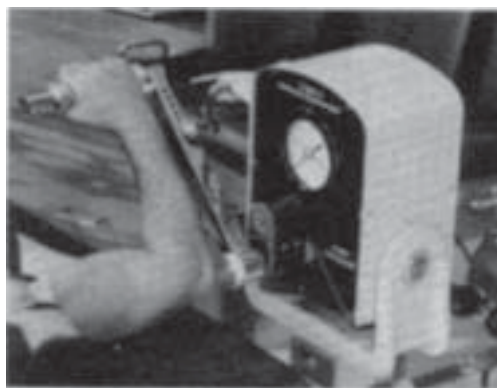

Source: Your Body Doesn't Lie, p. 47

CHAPTER ONE

WHAT MAKES MRT WORK?

LET'S EXPERIENCE MRT

Definition Muscle Response Testing (MRT) is a way of checking the energy flow within your body and discovering what organ(s) are under stress and need nutritional support and what kind of support they need.

It is one of the more bizarre things you will experience, and yet at the same time **one of the most helpful skills you will acquire**. One of the best ways to be introduced to MRT is to experiment with it yourself, so let's do that right now. Get a partner and have them participate with you in a simple experiment.

First, extend your right arm straight out in front of you, parallel to the floor. Lock your arm muscle and have your partner determine your baseline muscle strength by **gently** pushing down on your wrist. Now, hold some white sugar in your left hand and have your partner push down on your right arm again. See if you have the same strength, more, or less strength. Most people will find their arm has weakened, because the nerves in your left hand sent signals to your brain about what it was holding. Your brain made an instantaneous calculation and determined that the energy that was radiating from the product (sugar) would not be beneficial to your body's strength. Actually, you shocked your

body's system so that it temporarily weakened, and you were able to note that weakening in the decreased muscle strength of your right arm. (If your body is experiencing insulin problems, your arm may not go weak with this experiment.)

Try Muscle Response Testing with a bottle of aspirin in your left hand, then go around your kitchen cupboards, through your bottles of vitamins, and into your refrigerator. Test all sorts of items and discover which ones make your arm strong and which make it weak. You will probably be amazed at the difference in strength your right arm displays. I was.

Let's see if we can discover more precisely why this phenomenon takes place. (Later in this book you will learn skills which will help you overcome the problem of a spongy arm muscle or an uncertain Muscle Response Test result.)

OVERVIEW OF WHERE THIS BOOK WILL TAKE YOU

Now let's take the rest of Section One to discover **why** Muscle Response Testing works. First, we will examine a scientific basis for it, exploring four premises which underlie the practice of Muscle Response Testing. We will refresh our understanding of atoms, elec-

trons, electricity, and magnetism, and see how these relate to the practice of Muscle Response Testing. We will take the time to quote rather extensively from a recognized source of knowledge, the **Worldbook Encyclopedia**, to help satisfy our questioning and sometimes unbelieving minds. We want to nail this phenomenon down as clearly and authoritatively as we can from a scientific worldview.

We will then go on to lay out a biblical and spiritual foundation for Muscle Response Testing. We will leave no doubt concerning the fact that Muscle Response Testing falls well within the confines of biblical and spiritual principles. This is extremely important to the authors, as Mark and Patti are both Christians.

That will conclude Section One of this book. Some of you may desire to skip Section One for the time being and go directly into Section Two where you will learn the exact locations of approximately 40 Muscle Response Test points in the body. In that section, you can begin experimenting on your own body and discovering the amazing reality of Muscle Response Testing. However, you will need to come back to Section One at some point, because people will ask you why Muscle Response Testing works and you will want to give them both a scientific and biblical answer in order to resolve their curiosity and fears. So Section One becomes the foundation which must not be neglected.

Section Three will teach you a number of specific principles which will make you very successful as you practice MRT. You may think you do not need Section Three. You may think it is enough just to know the location of the points as taught in Section Two. However, that is not enough. There are a number of reasons why Muscle Response Testing will not immediately work on perhaps 50% of the people you test. Section Three will tell you why it is not working and what to do to get it working. So you will need Section Three in order to be fully effective with the people you test, and to stay fully legal while you test.

Section Four will tell you where you can go for further training in MRT, and how you can become certified and even ordained as a health care professional.

So now, let's get started!

MUSCLE RESPONSE TESTING IS BUILT UPON SEVERAL PREMISES:

PREMISE ONE: Your mind, which oversees countless bodily functions every minute of every day, **knows what is good for your body and what is not**. One

hundred trillion impulses per second travel between your mind and body.

Obviously, you are not aware of most of these. They are operating on the subconscious level.

For example: Your mind monitors every single detail of your body's systems, adjusting organs, glands, respiratory rate, heart rate, swallowing, blinking, water level in the body, etc.

PREMISE TWO: Your mind communicates to your body continuously through electrical (biomagnetic) energy flowing through your nervous system.

For example: When a medical doctor performs an electrocardiogram, he connects metal strips to the patient. These conduct

electricity to the electrocardiograph, which in turn amplifies the currents and records them on paper as a series of wavy lines. This is a record of the electrical currents which control the patient's heart muscles.



Your nervous system transmits one hundred trillion impulses per second

An electrocardiograph picks up and records electrical currents produced by the heart

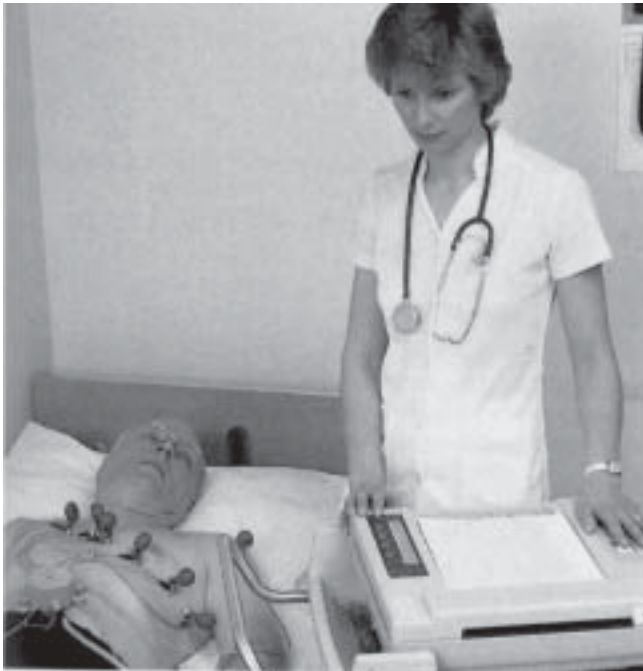

Source: World Book Encyclopedia, vol. 6, p. 197

An electroencephalograph is an instrument used to measure and record the electrical voltages produced by neurons (nerve cells) in the brain. A recording of this electrical activity is called an electroencephalogram (EEG). It is performed by medical doctors attaching electrodes to the patient's scalp.

The current theory on this electrical energy is that it is a flow of positively charged ions flowing through one's nerve cells. See **World Book Encyclopedia** under "Nervous System" for more detail on this process.

PREMISE THREE: The sensors of your body can pick up sensations (vibrations, frequencies) and respond to them.

For example: The nerves near the skin of your body can detect the vibrations of the products held against your body, and communicate this information back to your brain.

When you stop to think about it, most of us can sense the "vibes" in the air when we walk into a room. And there are certain people with whom we feel "in sync" and have instant rapport. I suspect part of that is our mind and body's ability to sense vibrations even through the air and respond to them (Matt. 9:4).

PREMISE FOUR: MRT gives your mind a method of communicating what it knows back to you.

For example: We have been told that we do not use 90% of our brains. Muscle Response Testing gives that 90% of your brain a way to communicate to you what it knows (much of this knowledge is on a subconscious level).

As you develop the art of muscle testing, you are learning a computer programming skill with a more sophisticated computer than any ever invented by man.

THE VALUE OF MUSCLE TESTING:

1. MRT is the easiest way available to customize a nutritional program for a specific individual's needs at any specific point in time. If your body starts to weaken, MRT will tell you about it long before you experience functional breakdown of an organ. If you have already experienced a breakdown in your body, MRT can show you what you must do so your body's healing resources can speed you on the way to recovery. The five stages of progression in a nutrient deficiency are: a) Nutrient reserves in the body are depleted, b) There is a depletion of the nutrient from the body's tissues, c) The depletion

Transmission of a nerve impulse

The transmission of a nerve impulse is an electrochemical process. Most experts believe the neuron membrane controls this process by selectively allowing ions to enter and leave the cell. These diagrams show how a motor neuron carries a message from an association neuron to an effector.

A resting neuron is polarized - that is, it's inside is more negative than it's outside. The membrane maintains the polarity by restricting the flow of ions in and out of the cell.

The impulse begins when neurotransmitters from the association neuron change the porosity of the motor neuron's membrane. This change results in depolarization.

The impulse spreads down a myelinated axon as the depolarization hops from one node of Ranvier to the next. The impulse shown has gone nearly halfway down the axon.

Chemical transmitters are released by specialized structures when the impulse gets to the neuron's end. These chemicals stimulate the effector, in this case a muscle.

Source: World Book Encyclopedia, vol. 14, p. 135

causes bio-chemical changes which can be detected in the blood or urine, d) Depletion causes functional changes which are manifest as symptoms: fatigue, gas, distress, lack of concentration, e) Depletion causes anatomical changes which include changes in skin, skeleton, tongue and other parts of the body. Doctors begin to diagnose at level five. MRT begins to diagnose at level one.

2. MRT involves the “patient” in the healing process, allowing you to take a greater degree of responsibility for your own health. Many times we don’t know exactly what to do to help our bodies get well. Through MRT, you will always know exactly what your body wants you to do to assist it in the healing processes.

3. Muscle testing helps enhance the placebo effect, and a positive use of the placebo effect enhances one’s recovery. Because the client has felt his muscle become strong when the right nutrient is put in his hand, he has an intuitive belief within him that this nutrient will help his body. This faith and belief aids in the healing process. The Bible says, “According to your faith, be it unto you.” Faith is a powerful force in promoting health, just as fear is a powerful force in promoting sickness.

“For the thing which I greatly feared is come upon me, and that which I was afraid of is come unto me” (Job 3:25).

SOME SCIENTIFIC BACKGROUND ON ATOMS, ELECTRICITY, AND MAGNETISM AS THEY RELATE TO MUSCLE RESPONSE TESTING

Most of us need to review a bit of high school science in order to restore a basic understanding of the “laws” of science which will help us understand how and why we can put a container of product in our hands and our bodies can instantly respond to it.

The facts we need to review are that:

- 1) **Everything** is made of atoms which contain electrons.
- 2) Electricity is the movement of electrons or ions (which are charged atoms).
- 3) Electricity creates a magnetic field.
- 4) Through induction, this magnetic field can influence objects nearby.

With this foundation, Muscle Response Testing will make sense.

In the sections below, we will quote heavily from the **Worldbook Encyclopedia**, as most people will recognize this as a scholarly source of unbiased information.

1) EVERYTHING IS MADE OF ATOMS WHICH CONTAIN ELECTRONS.

Related MRT Thesis: Any supplement we put in our hand has an electrical base and an atomic structure which vibrates at its own unique frequency. This frequency can be sensed by the nerves of our body and registered as something which strengthens or weakens us.

The **Worldbook Encyclopedia** tells us that:

“**Everything** around us consists of atoms. Atoms, in turn, are made of three main types of tiny particles: electrons, protons, and neutrons. Both electrons and protons have an electric charge. An electron has one unit of negative charge, and a proton has one unit of positive-charge. A neutron has no charge. Protons and neutrons are heavier than electrons and are crowded into the nucleus, the central core of an atom. Electrons whirl around the nucleus.” (Vol. 6 p 189).

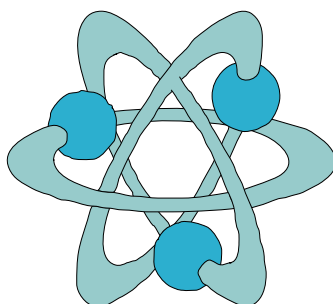

Everything around us is made up of atoms

Einstein demonstrated that at the core of all matter we find energy. He did this with his famous formula, $E = MC^2$ (energy equals mass times the speed of light squared). Mathematical laws tell us that $M = E / C^2$ (mass equals energy divided by the speed of light squared) is therefore also true, allowing us to define matter in terms of energy. So energy is at the core of our universe and at the core of all matter.

Every element, nutrient, color, and word vibrates at its own specific frequency. Our body can readily identify any object placed against its skin or any color placed before its eyes or any word that comes to its ears according to its unique frequency. And our brain, being in constant contact with, and control over, every single aspect of the body, can discern whether the object or color or word will strengthen or weaken the body’s processes. This is generally done on a sub-conscious level.

Again, the following section from the **Worldbook Encyclopedia** helps us by showing that a **major shift** in scientific understanding is occurring during this century. (Emphasis in the sections quoted below is added by the authors.)

“Quantum mechanics goes beyond the limits of classical physics, which is based on the laws formulated by the English scientist Sir Isaac Newton. It ranks as one of the major scientific achievements of the 1900’s. Quantum mechanics has contributed greatly to the development of such important devices as lasers and transistors. It also has enabled scientists to gain a better understanding of chemical bonds and chemical reactions.

“**Understanding quantum mechanics.** In an atom, tiny particles of negative electrical charge called electrons move in orbits around a nucleus of positive charge. Quantum mechanics shows that the electrons can move only in certain orbits. Each orbit, called a quantized orbit, has a particular value of energy. When an electron is in a given orbit, it exists at a specific energy level and does not release or absorb energy. An electron remains in this normal state as long as its atom is not disturbed. But if outside forces act on the atom, the electron can change to another quantized orbit.

“When an electron jumps from an orbit of higher energy to one of lower energy, it gives off energy as light. This light is released in the form of a tiny bundle of energy called a quantum or photon....

“Scientists once believed light was a wave emitted as a continuous flow. But quantum mechanics explains that light is a stream of separate photons, which have characteristics of both particles and waves. A photon behaves like a particle because it occupies a fixed amount of space. A photon also behaves like a wave because **it has a definite frequency** (number of vibrations per second), which is proportional to its energy.

“A photon’s frequency forms a single spectrum line that represents a **particular wavelength or color**. The atoms of a chemical element give off photons of a wide range of frequencies to produce many different lines. This series of lines makes up the chemical element’s spectrum, **which differs from that of any other element**. The frequencies of an element’s spectrum lines can be calculated by using quantum mechanics.

“Quantum mechanics shows that electrons and other atomic particles of matter are also associated with waves. These waves, called **matter waves**, have a specific wavelength.” (Vol. 16 p. 6)

So science helps us understand that when we place an item in our hand when muscle testing, that item contains energy with a specific wavelength or frequency. The body senses this frequency and responds to it, becoming stronger or weaker **depending on whether it is a frequency the body needs or doesn’t need**.

2) ELECTRICITY IS THE MOVEMENT OF ELECTRONS OR IONS (WHICH ARE CHARGED ATOMS).

“Ordinarily, an atom has an equal number of electrons and protons, and so it is electrically neutral. If an atom gains some electrons, it becomes negatively charged. If an atom loses some electrons, it becomes positively charged. Atoms that have an electric charge - either negative or positive - are called ions.” (Vol. 6 p.

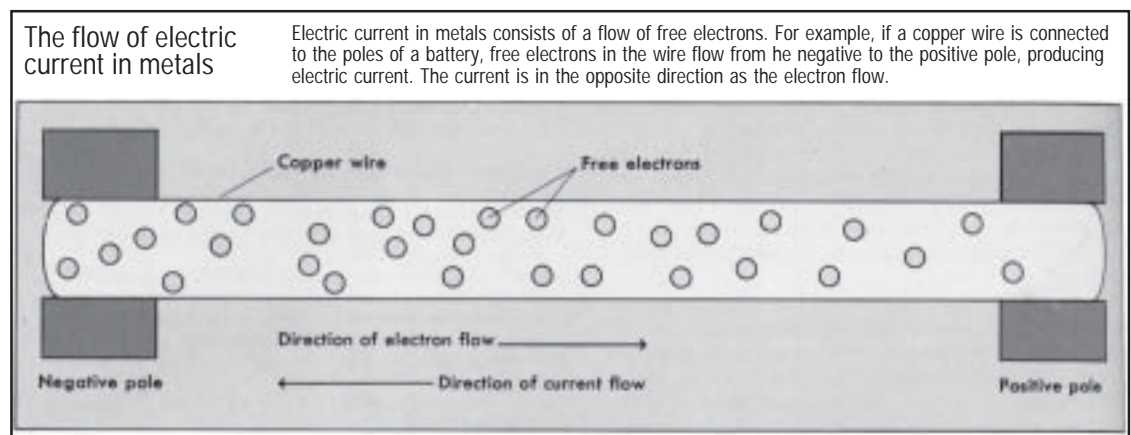

Source: World Book Encyclopedia, vol. 6, p. 192

189).

Since there are electrons within all nutrients, nutrients are, at their core, energy with varying frequencies.

3) ELECTRICITY CREATES A MAGNETIC FIELD.

“Every charged particle is surrounded by an **electric field**, the space around the particle in which the charge has an effect.” (Vol. 6 p. 189)

Magnetism. Electric current in a wire creates a magnetic field around the wire. If the wire is run through a sheet of cardboard on which iron filings have been sprinkled, the filings will form a series of circles outlining the field.

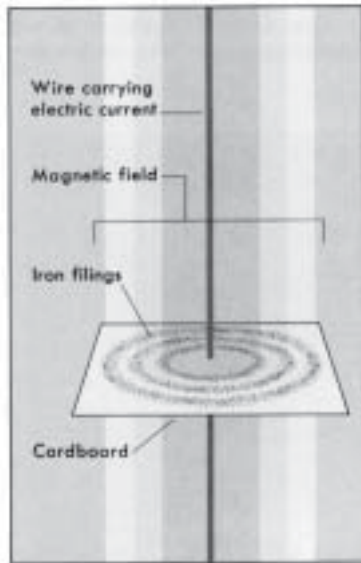

Source: World Book Encyclopedia, vol. 6, p. 193

“The region around a magnet, where the force of magnetism can be felt, is called a magnetic field. A conductor carrying electricity is always surrounded by a magnetic field.” (Vol. 6 p. 193).

Since the core of elements is electrical energy, every element (i.e. food, herb, supplement) creates its own minute magnetic field which can be measured and which extends out a small distance from the element.

4) THROUGH INDUCTION, THIS MAGNETIC FIELD CAN INFLUENCE OBJECTS NEARBY.

“Charged particles exert a force on one another, even when not in physical contact, because of their electric fields. For example, ions with unlike charges attract one another, and those with like charges repel one another.

“Electricity is sometimes classified as static electricity or current electricity, but both are actually made up of the same kinds of particles. Static electricity consists of electrons or ions that do not move. Current electricity is made up of moving electrons or ions. Almost all of the electricity we use is current electricity.

“You can generate static electricity by combing your hair briskly on a dry day. Your hair loses electrons and becomes positively charged. The comb gains electrons and becomes negatively charged....

“An object that has a stationary electric charge can charge another object by either contact or induction...Charging by induction occurs when a charged

object is placed near - but does not touch - another object. Suppose a positively charged glass rod is placed near an insulated metal ball. The rod will pull electrons in the ball to the side of the ball nearest the rod. The opposite side of the metal ball will then have a positive charge and will attract negatively charged particles.” (Vol. 6 p. 189-191).

It is because of the principle of induction that your cassette player works when you plug it into your 110 volt wall socket. Through induction, the cassette player transformer reduces the 110 volts down to the 12 volts the cassette player can use. A transformer works in the following way: The incoming electrical wire passes through a coil, inducing an increased magnetic field, and then returns to the wall socket. A second wire coil is adjacent to (but not touching) the first wire coil in the transformer and through induction, the second coil generates a current from the magnetic field of the first coil, which is used to operate the cassette recorder. The ratio of the number of coils of wire in each coil determines the voltage and thus the current that comes out of the

A typical transformer consists of two coils of wire wound around the sides of a core of thin iron sheets. The ends of the primary winding are connected to the source of the voltage that is to be changed. The ends of the secondary winding are connected to the circuit to which the electricity is to be transferred.

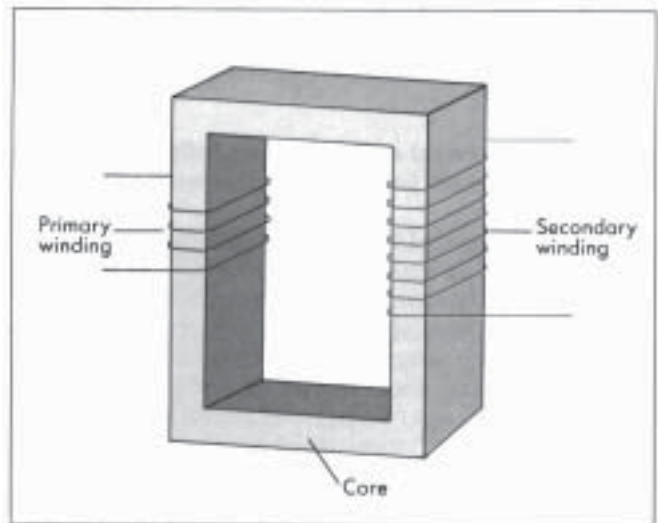

Source: World Book Encyclopedia, vol. 19, p. 372

other side of a transformer. See the diagram below.

When you hold a product in your hand for MRT, even if it is in a plastic or glass container, it emits an energy field which, **through induction**, interacts with the nerves in your hand (or any part of your body in contact with the container of product). The nerves transmit the frequency induced through the container to your

brain and within a split second, your brain has made the decision that this frequency will either strengthen or weaken your muscles. This conclusion is demonstrated by experiencing strengthened or weakened muscles throughout your body.

If you place some small metal ball bearings on a glass or plastic plate and move a magnet around under the plate, you will, of course, observe that the ball bearings move also. Similarly, herbs and products in plastic bottles, when placed in one's hand, emit an energy field which can be sensed by the nerves in your hand, even through the bottle.

If you consider the positive and negative poles of a magnet, you will remember that like charges repel and unlike charges attract. Careful observation has taught us that the bottoms of the feet and the palms of the hands are negative. The tops of the feet, the tops of the hands, and the top of the head are positive. You stand on the crust of the earth, which is positive. Thus it makes sense that when you walk barefoot on the earth, you should feel energized because the bottoms of your feet (negative charge) are walking on a positively-charged earth. The charge pushes you up and onward. However, if a person's polarity is off, all of this is reversed. That means every time he takes a step he feels more and more tired. We will discuss ways of testing and adjusting one's polarity later in this book.

This gives you a basic scientific understanding of how and why Muscle Response Testing works.

WHAT HAPPENS WHEN YOU TOUCH A MUSCLE RESPONSE TEST POINT ON YOUR BODY?

With muscle testing, you can touch many different specific areas of the body to determine the energy flow in that area of the body.

When you use the strategy of touching a Muscle Response Test point on your body, you connect with the energy field in that particular area of your body, and your body gives you a response based on how that particular organ is doing, whether it is stressed or normal. If it is stressed and receiving an extra shot of energy to keep it going, when you add your energy to the field (by touching it), it "blows the circuits" and the arm goes weak, giving the signal that this particular organ is under stress. If the organ is not stressed, the addition of your extra energy will not be enough to "blow its circuits" and the arm will remain strong, giving you a signal that the organ is doing fine.

It is also true that your body is a magnet. We already know that the body has electricity flowing through it. That is why doctors can perform EKG's successfully. We also know that electrical flow produces a magnetic field. So we have a weak magnetic energy field around us which can be probed and tested. There are even instruments available which can and do measure this weak energy field. Kerlian photography can photograph this field. The painters of the Middle Ages often saw this field and re-created it as halos around the heads of saints. Many in the Western culture have lost their sensitivity to these spiritual phenomenon.

FREQUENCIES AND BODILY ORGANS

Every organ or gland in your body contains a concentration of a particular mineral or nutrient. This mineral concentration gives every organ and gland in your body its own specific rate of vibration or frequency.

For example:

- * the thyroid is an iodine organ
- * the heart is a potassium organ
- * the stomach is a sodium organ
- * the liver is an iron organ
- * the prostate is a zinc organ
- * etc.

God has designed all these bodily organs to play together in a wonderful orchestration, each organ being tuned to its own frequency.

If the thyroid gets out of tune, you have a thyroid problem. Iodine re-tunes the thyroid to the proper frequency (i.e. the frequency of iodine), thus restoring its function. Iodine normalizes the thyroid. If the thyroid frequency is too fast, it tunes it down. If it is too slow, it tunes it up. In this way, foods and the nutrients in them restore your body to health.

The person with a thyroid problem would therefore want to feed his body a plant which is high in iodine, such as kelp, dulse, or black walnut. He could grow his own herbs, but most of our lives are a bit too busy for that. Therefore, rather than our needing to go to the field to pick the plant, the plant has been harvested by an herb company, put into a capsule, and made ready for purchase. That makes it easier for most of us to get restorative quantities of quality nutritional substances into our bodies. This is the way I have chosen to go.

Man was made from the dust (elements) of the ground. The plants which grow, soaking up the elements of the ground, re-tune the organs in our bodies to their proper frequencies. The Bible says “He causeth the grass to grow for the cattle and herbs for the service of humanity” (Psalms 104:14 KJV).

It often takes about three months to restore a deficiency, although you may experience some symptomatic relief within a few days or weeks. You should expect to add an extra month for healing for every year you have been sick. Herbs work slower than pharmaceutical medicines (which are often derivatives of herbs). The herbs God has given us are food and are non-toxic.

BECOMING SKILLED “COMPUTER PROGRAMMERS”

Obviously, our brains are much superior to the most powerful computer available today. If you are skilled enough in computer programming to know how to get information out of a computer, it can feed you a lot of vital information. The more skill you gain in MRT and kinesiology, the better brain/computer programmer you will become, and the more your mind and body will tell you. And the healthier you will become. It seems to me that it is well worth taking six months of our lives to master MRT so we can learn a lot of what our unconscious minds know. What do you think?

BIBLICAL PRINCIPLES WHICH RELATE TO MUSCLE TESTING

Now let us gain a biblical/spiritual understanding of the principles involved in the practice of muscle testing, and become comfortable that the phenomenon of MRT clearly falls within a biblical framework. Recalling what we have already learned from science about the wonder and marvel of God’s creation, let’s examine Scripture.



1. God spoke the worlds into being. All matter came originally from spiritual energy. Therefore spiritual energy is the foundation of matter. This corresponds exactly with what quantum physics has discovered.

“And God said, ‘Let there be light:’ and there was light.”

Genesis 1:3

“And God said, ‘Let there be a firmament in the midst of the waters, and let it divide the waters from the waters.’”

Genesis 1:6

“And God said, ‘Let the waters under the heaven be gathered together unto one place, and let the dry land appear:’ and it was so.”

Genesis 1:9

“And God said, ‘Let the earth bring forth grass, the herb yielding seed, and the fruit tree yielding fruit after his kind, whose seed is in itself, upon the earth:’ and it was so.”

Genesis 1:11

2. God’s energy sustains every molecule of the universe. Again, this shows that there is an energy base to every atom of the universe.

“He is before all things and in Him all things hold together.”

Col. 1:17 NASB

*“Who being the brightness of His glory, and the express image of His person, and **upholding all things by the word of His power**, when He had by Himself purged our sins, sat down on the right hand of the Majesty on high;”*

Hebrews 1:3

3. Man is created from the dust of the earth. This dust is made up of the atoms which are held together by God’s energy.

“And the LORD God formed man of the dust of the ground...”

Genesis 2:7

4. God gave man the herbs of the earth to sustain himself. Those foods and herbs which grow from the soil bring with them nutrients from the soil which strengthen and restore the organs of the body.

“And God said, ‘Behold, I have given you every herb bearing seed, which is upon the face of all the earth, and every tree, in the which is the fruit of a tree yielding seed; to you it shall be for meat.’”

Genesis 1:29

“...and the fruit thereof shall be for meat, and the leaf thereof for medicine.”

Ezekiel 47:12

5. God breathed into man the breath of life and man became a living soul. So mankind has an additional energy from God. God is Spirit, and He has created mankind with a spirit also.

“...and breathed into his nostrils the breath of life; and man became a living soul.”

Genesis 2:7

6. At the point of salvation, man’s spirit is renewed and indwelt by the Holy Spirit, which invigorates man’s whole being: spirit, soul, and body.

“Then Peter said unto them, ‘Repent, and be baptized every one of you in the name of Jesus Christ for the remission of sins, and ye shall receive the gift of the Holy Ghost.’”

Acts 2:38

“But he that is joined unto the Lord is one spirit.”

1 Corinthians 6:17

7. God has made healing power available to the Church through the laying on of hands. This extra dose of spiritual energy can and does restore the spirit, soul, and body of man. It is wise for one involved in the healing profession to lay hands on people and pray for them to be healed when they are sick.

When operating in the healing anointing of the Holy Spirit, additional amounts of energy flow through one’s body and out into others whom you touch. Jesus could sense the energy flow of the Spirit of God as it was released to others. We, too, if we become sensitive, can sense the energy flow within our own bodies and to others’ bodies. Often it is sensed as warmth, heat, and vibration in the hands. Tune to intuition when you lay hands on people and pray for them and see if you don’t sense these things.

Jesus asked, “Who touched me?” He had noted that **virtue (i.e. power) had flowed from Him.**

“And Jesus, immediately knowing in himself that virtue had gone out of him, turned him about in the press, and said, ‘Who touched my clothes?’ And his disciples said unto him, ‘Thou seest the multitude thronging thee, and sayest thou, ‘Who touched me?’”

Mark 5:30,31

AN EXAMINATION OF THE WORDS FOR “POWER” IN THE NEW TESTAMENT

1. There are three words translated as “power” in the New Testament. **Energes** is very interesting in light of our discussion.

Exousia (used 108 times) means “right or prerogative”

Dunamis (used 118 times) means “might or power”

Energes (used 31 times) means “active energy”

2. Following is an example of *energes* as active energy within a person. The word translated from *energes* is bold in the following verse.

*“Whereunto I also labour, striving according to his **working**, which **worketh** in me mightily.”*

Colossians 1:29

3. When one is anointed for ministry, he has increased energy rubbed into his being.

The Hebrew word for “anointing” is *mischah* which means “smearing”. The Greek word for “anointing” is *charisma* which means “a rubbing in”. There is a tangible impartation of the substance of the anointing upon a person when he is anointed.

Elisha’s bones had so much anointing rubbed into them that when a dead man touched Elisha’s dead bones, the dead man was resurrected (2 Kings 13:21)!

4. The ministry of healing is to involve laying on of hands, which allows the healing energy of God to flow into the sick person.

“They shall take up serpents; and if they drink any deadly thing, it shall not hurt them; they shall lay hands on the sick, and they shall recover.”

Mark 16:18

5. Energy can be passed even into inanimate objects.

“Handkerchiefs or aprons were carried away from Paul’s body to the sick, and the diseases left them and the evil spirits went out.”

Acts 19:12

Even Peter’s shadow conveyed healing power (Acts 5:15).

(Note: Spiritual energy seems to be similar to electrical energy in that an item can carry a charge [i.e. static electricity] which can be released upon touch.)

A SUMMARY THOUGHT:

In times of strong anointing, such as is currently occurring at the Toronto Blessing, it is observed that people begin to shake and vibrate under the power of the Holy Spirit. I wonder if their bodies are not sensing the energy of the Holy Spirit, (which I assume, like everything else in the universe, has its own unique frequency). By drawing near to the “voltage” of the Holy Spirit, they are experiencing induction and their bodies are picking up a reduced voltage from the Holy Spirit, very similar to the transformer in a cassette recorder which we spoke of earlier. What do you think?

SUGGESTIONS FOR THE LAYING ON OF HANDS

When through MRT I discover an organ which needs help or healing, I lay my right hand on the front of the patient’s body directly on the organ and my left hand on the back of his body directly behind the organ, and pray in the Spirit. Heat flows between my hands for about five minutes, which the subject can generally feel as well. After the warmth fades, I remove my hands. I believe healing is greatly stimulated in this way. I believe a healing professional should offer healing prayer as an integral part of his healing ministry.



Wendell Whitman suggests using the Lord’s prayer when you are laying hands on an individual. He finds that especially when he gets to the section, “Forgive us our sins as we forgive those who sin against us...” a tremendous amount of heat will flow between his hands. Rather than taking five minutes for the prayer time, it is over in a minute or so. Experiment with the two ways suggested above and see what seems best for you.

THE BIBLE SPEAKS CONCERNING THE POWER IN THE RIGHT HAND

“Thy right hand, O LORD, is become glorious in power: thy right hand, O LORD, hath dashed in pieces the enemy.”

Exodus 15:6

“And of the rest of the oil that is in his hand shall the priest put upon the tip of the right ear of him that is to be cleansed, and upon the thumb of his right hand, and upon the great toe of his right foot, upon the blood of the trespass offering.”

Leviticus 14:17

“I have set the LORD always before me: because He is at my right hand, I shall not be moved.”

Psalms 16:8

“The LORD is thy keeper: the LORD is thy shade upon thy right hand.”

Psalms 121:5

“A wise man’s heart is at his right hand; but a fool’s heart at his left.”

Ecclesiastes 10:2

“For I the LORD thy God will hold thy right hand, saying unto thee, Fear not; I will help thee.”

Isaiah 41:13

“Mine hand also hath laid the foundation of the earth, and my right hand hath spanned the heavens: when I call unto them, they stand up together.”

Isaiah 48:13

“Jesus saith unto him, Thou hast said: nevertheless I say unto you, Hereafter shall ye see the Son of man sitting on the right hand of power, and coming in the clouds of heaven.”

Matthew 26:64

“For David speaketh concerning him, I foresaw the Lord always before my face, for he is on my right hand, that I should not be moved:”

Acts 2:25

(Also see Gen. 48:14-18; Psalms 20:6; Psalms 48:10; Psalms 98:1; Psalms 110:1; Psalms 118:15; Isaiah 62:8; Matthew 25:33; Acts 3:7; Acts 5:31; Acts 7:55; Romans 8:34; Colossians 3:1; Hebrews 1:13; Hebrews 8:1; 1 Peter 3:22; Revelation 1:16; Revelation 1:17.)

THE AWESOME POWER OF WORDS UPON OUR BODIES

“Death and life are in the power of the tongue.”

Proverbs 18:21

1. “For as he thinketh in his heart, so is he” (Proverbs 23:7). The words we think within our minds send a message to every cell in our bodies, creating for us what we have spoken in our hearts. This shows the awesome power of words, even when thought quietly within our hearts. Our whole being hears them and is affected by them, either for good or for bad.

2. “Beloved, I pray that in all respects you may prosper and be in good health, just as your soul prospers” (3 John 2). In this verse, outer, physical health is clearly connected to the health of our souls (i.e. mind, will, and emotions). So again we see that the thoughts we think affect our bodies.

3. “And Jesus, knowing their thoughts said, `Wherefore think ye evil in your hearts?’” (Matthew 9:4). This refers to a phenomenon which many of you have probably experienced in your lives. You come into the presence of a person, and you have a sense of what they are thinking. You just feel it. Your inner man senses their inner man. It “reads” what is going on, and you are inwardly aware of their thoughts. We know that Jesus laid aside his divine powers when he became a man (kenosis passage: Phil. 2:5-8), so this was not a “special” ability He had because He was the Son of God. I believe God

has designed us with this wonderful ability to sense, even though the Western world knows little about it at this time. I also believe God wants to overlay this natural ability with His gifts, such as a word of wisdom and a word of knowledge. Satan, too, wants to overlay it with various psychic phenomena, so we must be careful to present ourselves to God, and stay within realms God has allowed us to operate in. (i.e. Stay away from fortune telling, witchcraft, astrology, and other forbidden psychic phenomena).

Therefore, based on the biblical text, we see that we can sense each others’ hearts. Most of us have already experienced this phenomenon. Mothers instinctively know when their children are in danger and begin praying for them. When you walk into a room, your heart senses the “vibes”, and sensitive people may even sense what the people have been discussing.

In MRT, a tester can actually ask in his heart a question of the client (or make a statement in his heart), and the client’s heart can hear and respond with either a strong or weak muscle, depending on whether the statement or question is true or false. A strong muscle equals true and a weak muscle equals false. However, it is extremely important that you keep all questions to **things the person’s body would know the answer to**.

IS MUSCLE TESTING EVIL???

Occasionally you will hear the charge that muscle testing is evil, New Age, or witchcraft. In answering this charge, we need to ask, “What methodology does the person making the accusation use for discovering truth, and did he apply his methodology to this specific issue before making his negative claim?” Some people’s approach is, “If it is outside of my knowledge base, then it must be evil.”

Over the years, I have used several methods for discovering truth. My first approach was, “If Dad said it, it must be true.” As I grew, my approach became, “If my teacher said it, it must be true.” When I became a Christian, I thought, “If my pastor said it, it must be true.” In Bible college I decided, “If my interpretation of the Bible says it is true, then it is true.”

I have now rejected all of these earlier approaches in favor of that detailed below, which is being used in this book.

THE BIBLE TEACHES AN APPROACH FOR DISCOVERING TRUTH

It has been called “The Leaders’ Paradigm” because those who follow this process which God has ordained are led by God into the fulfillment of His purposes in their lives. God’s purposes for us involve leadership (Deut. 28:12-13).

The Leaders’ Paradigm is built on the following six pillars. It allows the Holy Spirit to reveal truth to us using six different approaches. It is built upon the conviction that the Holy Spirit is the Teacher in our lives (Jn. 14:10,16,17,21;1 John 3:20,27).

Pillar One — Illumined Scriptures (Luke 24:32) This pillar is experienced as the Holy Spirit illumines Scriptures to us — we sense them leaping off the page or just coming to our attention spontaneously.

Pillar Two — Illumined Thoughts in One’s Mind (Luke 1:3) This pillar is experienced as the Holy Spirit guides our reasoning processes through spontaneous impressions. It is obvious that Luke’s gospel was **more** than simply investigative research of his own mind, as what he wrote has stood as the Word of God for 2000 years.

Pillar Three — Illumined Witness in One’s Heart (Mark 2:8) Deep inner peace or unrest is often part of this experience.

Pillar Four — Illumined Counsel of Others (Prov. 11:14) This pillar is experienced as one asks his/her spiritual advisors to seek God for confirmation, additions, or adjustments in the guidance he senses God has given him.

Pillar Five — Illumined Understanding of Life’s Experiences (Matt. 7:16) This pillar is experienced as one asks God to give him insight and understanding concerning the fruit life is demonstrating. God gives him revelation as to what has caused the fruit.

Pillar Six — Illumined Revelation from God Through Dreams, Visions, Prophecy, and Journaling (Acts 2:17) This pillar is experienced as you receive direct revelation from God through dreams, visions, and journaling. Journaling is the writing out of your prayers and God’s answers.

The wise leader has a solid foundation of Scripture within him which underlies the use of these six pillars and has a goal of glorifying God in all he does. He looks for all six of the pillars to line up before he assumes a direction.

HOW DO WE JUDGE THINGS NOT SPECIFICALLY MENTIONED IN THE BIBLE?

STANDARD ONE — ILLUMINED SCRIPTURES (LUKE 24:32)

It is in conformity with biblical principles, i.e.:

- * It demonstrates the principle of order and design.
- * It works in harmony with God’s design, promoting life.

STANDARD TWO — ILLUMINED THOUGHTS IN ONE’S MIND (LUKE 1:3)

Honest, trustworthy studies and research have been done which demonstrate its value and effectiveness.

STANDARD THREE — ILLUMINED WITNESS IN ONE’S HEART (MARK 2:8)

There is a comfort and peace in the knowledgeable person’s heart concerning this truth. I personally am uneasy about just about everything I do not understand or have been taught is evil. So I must discern whether my uneasiness is on my soul’s level and a result of my ignorance or bad teaching, or whether it is the discernment of my spirit.

STANDARD FOUR — ILLUMINED COUNSEL OF OTHERS (PROV. 11:14)

Numerous spiritual, knowledgeable people render their support.

STANDARD FIVE — ILLUMINED UNDERSTANDING OF LIFE’S EXPERIENCES (MATT. 7:16)

Insight into life’s experiences demonstrates its effectiveness.

STANDARD SIX — ILLUMINED REVELATION FROM GOD THROUGH DREAMS, VISIONS, PROPHECY, AND JOURNALING (ACTS 2:17)

Various spiritual experiences confirm its use.

THE PHARISEES ALWAYS RESIST THE HOLY SPIRIT

I think we all need to beware of any levels of phariseeism within ourselves. Pharisees do not use the Leaders' Paradigm. They do not depend on the Holy Spirit in their process for discovering truth. They ignore the Holy Spirit and live out of Biblical Law ONLY, rather than out of the Word and the Spirit as Jesus did (Jn. 5:19,20,30).

You will recall that the Pharisees always stoned the prophets (Acts 7:52) and even killed Jesus. Not that the Pharisees did not love God. They did. They thought they were doing God a favor in killing Jesus. And they loved the Word of God. However, they loved their traditions just a bit too much. And they used their traditions to invalidate portions of the Word of God and to explain why they no longer needed to be kept. Each of us must examine our lives diligently to be sure we have not fallen into the trap of becoming a modern-day Pharisee.

The Bible is **crystal clear** that the Christian is to live and walk in the Spirit (Gal. 5:25), to pray in the Spirit (Jude 20), to be filled with the Spirit (Eph. 5:18), and to worship in spirit (Jn. 4:23). The Spirit is that inner, energizing force which is not matter. He is a Person whose Presence is felt as a spiritual energy which is sometimes referred to as the anointing.

To reduce life to matter alone is to remove the power of the Holy Spirit from the experiences of life and to focus on the worship of the false gods of our culture — rationalism, humanism, and a mechanistic approach to the universe rather than a vitalistic one. The Bible (Col. 1:17) and the most up-to-date science ($E = MC^2$) both confirm that energy is at the core of the universe.

The energy of God holds this universe together (Col. 1:17).

STANDARDS FOR JUDGING WHICH THE FEARFUL USE AND WHICH ARE NOT TAUGHT IN SCRIPTURE:

1. HEATHENS DO IT, SO IT MUST BE BAD. God rains on the just AND THE UNJUST (Matt 5:45). Moses received wise counsel from his father-in-law Jethro, a heathen, and acted upon it (Exodus 18). Daniel spent three years being trained in Nebuchadnezzar's court, learning the "literature and the language of the Chaldeans" (Dan. 1:4) and yet "God gave [him] knowledge and intelligence in every branch of literature and wisdom; Daniel even understood all kinds of visions and dreams" (Dan. 1:17). God can overlay your learning with an anointing of the Holy Spirit and help you see things others don't see. This will cause your superiors to be impressed with your knowledge and performance (Dan. 1:19).
2. IT IS EASTERN, SO IT MUST BE BAD. Jesus was not a Westerner.
3. IT INVOLVES SPIRITUAL ENCOUNTER, SO IT MUST BE BAD. The Bible is full of spirit encounter from Genesis to Revelation.
4. IT IS NEW AND DIFFERENT, SO IT MUST BE BAD. The only constant is change. Nowhere does the Bible teach that new is necessarily evil. "Behold, I will do a new thing; now it shall spring forth; shall ye not know it?" (Isaiah 43:19). Jesus even said to His disciples, "I have yet many things to say unto you, but ye cannot bear them now" (John 16:12).
5. I DON'T UNDERSTAND IT, SO IT MUST BE BAD.

"Trust in the LORD with all thine heart; and lean not unto thine own understanding. In all thy ways acknowledge him, and he shall direct thy paths."

Proverbs 3:5,6
6. IF PEOPLE MAKE MONEY FROM THE IDEA, IT MUST BE BAD.

"...the workman is worthy of his hire."

Matthew 10:10

7. I AM NOT SURE ABOUT IT, SO I WILL CALL IT EVIL.

“Woe unto them that call evil good, and good evil; that put darkness for light, and light for darkness; that put bitter for sweet, and sweet for bitter!”

Isaiah 5:20

It is a serious sin to call things evil which are not and to call things good which are not, especially if we are teachers and passing our careless “judgments” on to others. Getting on God’s “woe” list is not a valuable asset in life. It will indeed set one back a good way.

THE FEARFUL PULL BACK

Fear is a motivating force which satan uses effectively in many people. The Bible makes it abundantly clear that perfect love casts out fear (1 Jn. 4:18).

The Spirit-filled Christian will be moved by faith joined with the aggressive commission of Jesus Christ to disciple all nations (Matt. 28:19).

The fearful are afraid of everything new, of every challenge, and of forces around them that they can’t control or understand. In their fear, they generally come against all new ideas, cower at every new challenge, and hide from the powerful forces they assume to be hostile.

THE PHARISEES AND THE FEARFUL RESIST WHAT THE SPIRIT OF GOD IS DOING IN THE WORLD IN THEIR DAY.

Beware that you not become trapped in their snares. You will recognize them by their unwillingness to incorporate the working of the Holy Spirit in their lives or their methodology for discovering truth. They move in fear, resisting what God is doing in the earth in their day. They carry with them the spirit of murder, and always stone the messenger who brings word of the new thing God is doing in their world (Acts 7:51,52).

To safeguard yourself, use the Leaders’ Paradigm and move in spiritual knowledge and faith. I recommend that you only listen to teachers who do the same. Learn to hear the voice of God yourself, so you can be filled with the Lord’s words of faith and comfort. The Bible says “My sheep hear My voice” (Jn. 10:27).

ONLY THOSE WHO SEEK TRUTH FIND TRUTH!

“Blessed are they which do hunger and thirst after righteousness: for they shall be filled.”

Matthew 5:6

“Blessed are the pure in heart: for they shall see God.”

Matthew 5:8

Some people do not hunger and thirst after righteousness. (Righteousness, of course, embodies truth.) Some hunger and thirst to prove themselves right. Some people do not have a pure heart. Instead they hunger and thirst to prove others wrong.

For example, one gentleman, who was in charge of producing a major “medical” bulletin for a well-known and well-respected evangelical Bible teacher, evaluated modern alternative medical approaches. He offered this comment: “I started out to prove that these alternative methods were quackery, and I found out that they were occult.”

Well, when you start out with the objective of proving someone wrong, you have begun your search with impure motives and your search for truth will not be fulfilled. You have taken an adversarial attitude in your heart. This is strictly forbidden in Scriptures. It is satan who is the adversary and accuser (Matt. 13:39; Rev. 12:10,11). We are not to take on his heart when we search for truth. We are to take on the heart of the Holy Spirit. We are to come alongside and comfort (Jn. 14:16,17).

When the Bereans heard a NEW teaching, they did not try to prove it wrong; they tried to prove it right (Acts 17:11). Let us be more noble-minded, as the Bereans were, and seek to prove people RIGHT, not prove them wrong. Of course, in the above illustration, the “Bible teacher” was able to prove that ALL alternative approaches to medicine were false, and that the allopathic approach to medicine used by traditional doctors today and which focuses on the the use of drugs was “biblical”. What other outcome would be possible, given his starting point?

Hopefully these few thoughts will help you in thinking through a Spirit-led, Biblical approach for processing new ideas. For those interested, Mark Virkler has written more extensively on these topics in others of his books. A free list of his books is available from his offices.